

FONTANE BIANCHE

A TALE OF TWO FAMILIES

Salvatori+Fantini. Due aziende protagoniste della creatività imprenditoriale che ha dato lustro al design italiano. Entrambe a carattere familiare e sorte nell'immediato dopoguerra, costituiscono il punto di riferimento fra produzione e innovazione nel panorama delle piccole imprese italiane.

Nel 1946 Guido Salvatori dà vita a un'attività legata alla lavorazione della pietra vicino alla costa toscana e, appena un anno dopo, Giovanni ed Ersilio Fantini iniziano a produrre rubinetti sulle rive del lago d'Orta, tra le montagne del Piemonte.

Lo sviluppo di tecnologie avanzate e la ricerca estetica, accompagnate dalla passione per la tradizione artigianale, sono il terreno comune dove è maturata la loro collaborazione.

La rinomata abilità di Salvatori nel trasformare la pietra in texture e oggetti si coniuga perfettamente con l'esperienza e la maestria di Fantini nel lavorare il metallo per dare sempre nuove forme all'acqua.

Il risultato è il nuovo progetto Fontane Bianche, una fusione naturale e sorprendente tra la nobiltà della pietra e la presenza dell'acqua.

Salvatori+Fantini. Two companies which epitomise the spirit of Italian entrepreneurship and design. Both family businesses which at first glance are typical of the myriad of firms which form the backbone of the Italian economy. But upon a closer look, they share characteristics which perhaps set them apart from many of their counterparts.

Innovation has always been the cornerstone of both companies, right from 1946 when Guido Salvatori started a small stone business near the Tuscan coast, just a year before Giovanni and Ersilio Fantini began their own enterprise producing tapware on the shores of Lake Orta in the mountains of Piedmont.

A mutual passion for excellence and the desire to blend creativity with technology laid the foundation for a joint collaboration. Salvatori's renowned skill in transforming stone into beautiful textures and objects sits perfectly with the expertise and craftsmanship of Fantini and the result is Fontane Bianche, a natural and stunning fusion of stone and water.

FONTANE BIANCHE BY ELISA OSSINO

Il progetto nasce da una ricerca sulle forme archetipe tradotte in geometria pura e reinterpretate in chiave contemporanea.

Metafora del rapporto tra psiche e materia, il dialogo tra cerchio e quadrato attraversa tutta la collezione: il lavabo è un blocco quadrato in marmo da cui è sottratta una semisfera, la semisfera diventa una ciotola su un piano rettangolare sottile come un foglio, i raggi del cerchio diventano i rubinetti.

La ricchezza dei materiali – marmo e pietre per i lavabi e finitura in metallo brunito per i rubinetti – esalta la purezza delle forme.

La collezione prende il nome da una località con le sabbie bianche in Sicilia vicino Siracusa, chiamata così per le numerose fontane naturali di acqua dolce che sgorgano nel mare.

La ninfa Aretusa, correndo libera tra i boschi del Peloponneso, fu vista da Alfeo, che si innamorò perdutamente di lei. La giovane per sfuggirgli chiese aiuto ad Artemide, che la avvolse in una spessa nube sciogliendola in una fonte sul lido di Ortigia.

The collection was inspired by studying archetypical shapes translated into pure geometry and then reinterpreted in a contemporary way.

A metaphor for the relationship between psyche and substance, the dialogue between circle and square runs through the collection. A basin shaped from a marble square is softened by a sphere carved out of it. In turn, that sphere becomes a bowl, resting on a thin rectangular top. The rays of the circle become the tap.

The purity of forms is enhanced by the noble materials: marble and natural stone for the basins and burnished metal for the tapware.

The collection takes its name from the Sicilian beach known as Fontane Bianche (White Fountains) near Siracusa, famous for its rivulets of fresh water which run into the sea. *Running freely among the forest of the Peloponnese, the water nymph Arethusa was spotted by Alpheus, who became madly in love with her. In order to escape, she begged assistance from Artemis, who wrapped her in a thick cloud and dissolved her in a spring on the shores of Ortygia.*

Lavabo: Alfeo in Bianco Carrara / Parete: Tratti in Bianco Carrara
con inserti in alluminio in midnight black
Basin: Alfeo in Bianco Carrara / Wall: Tratti in Bianco Carrara
accented with aluminium inserts in midnight black

ART. P404B+P404A
Miscelatore lavabo da soffitto, lunghezza bocca 135 cm / Cartuccia progressiva
Ceiling washbasin mixer, spout length: 135 cm / Progressive cartridge
ART. P404C
Specchio, ingranditore, Ø 20 cm, con pantografo fisso
Mirror, magnifying, Ø 20 cm, with fixed pantograph



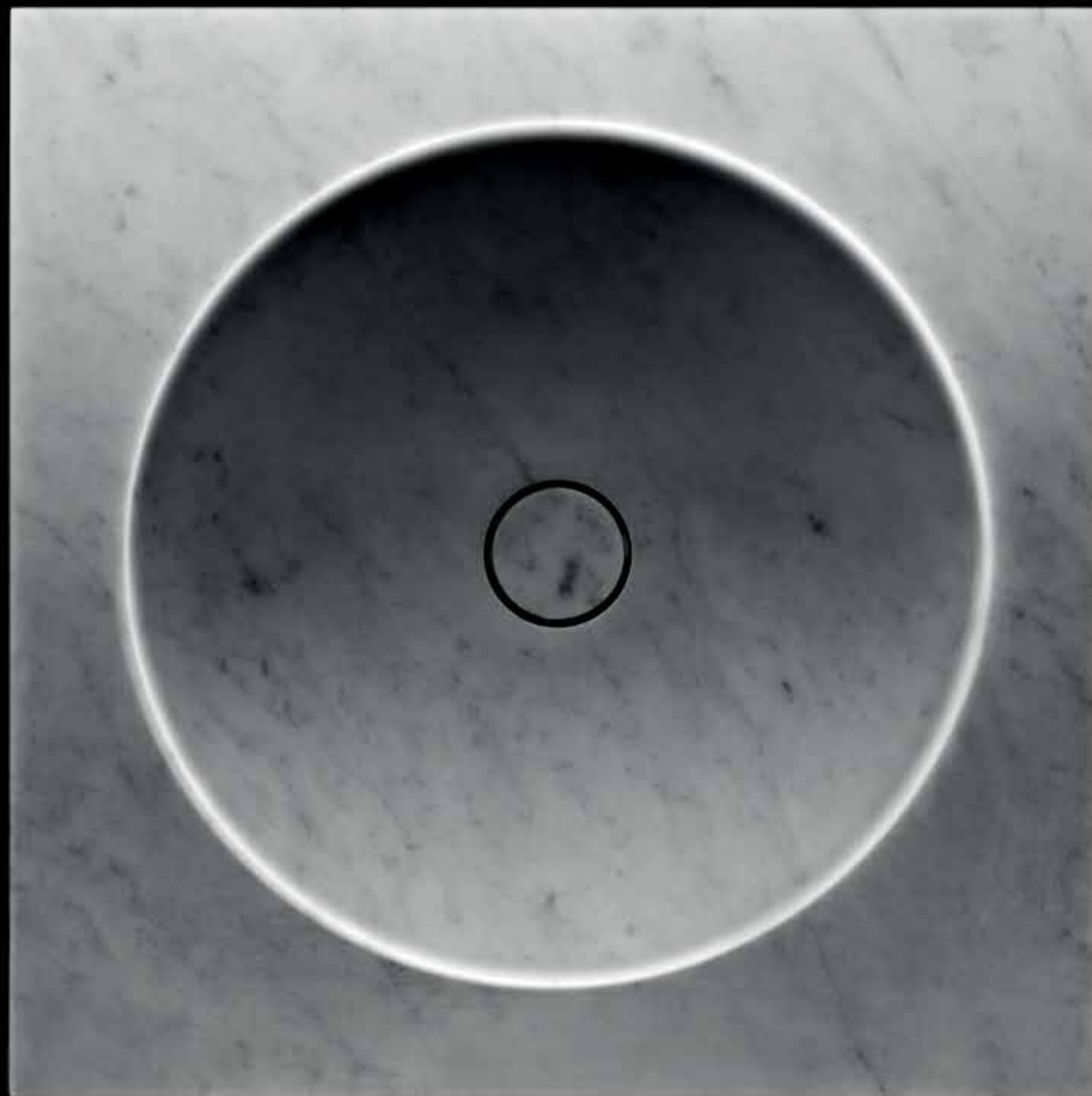
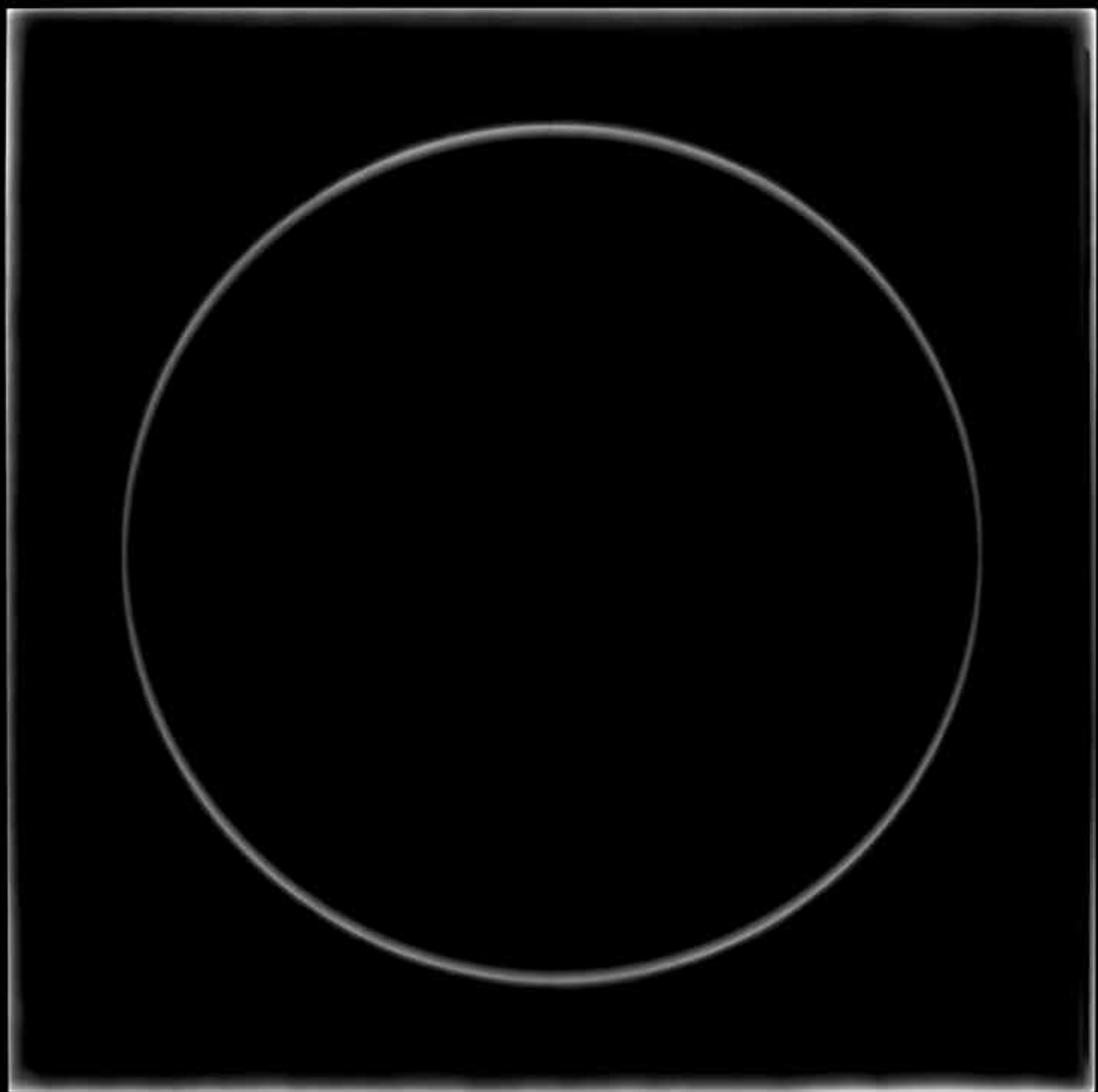

Parete: Tratti in Bianco Carrara con inserti in alluminio midnight black
Pavimento: Bianco Carrara levigato / Vasca: Oyster in Bianco Carrara
con rivestimento Tratti, come descritto sopra
Wall: Tratti in Bianco Carrara accented with aluminium inserts in midnight black
Floor: Honed Bianco Carrara / Bathtub: Oyster in Bianco Carrara,
clad in Tratti, as described above

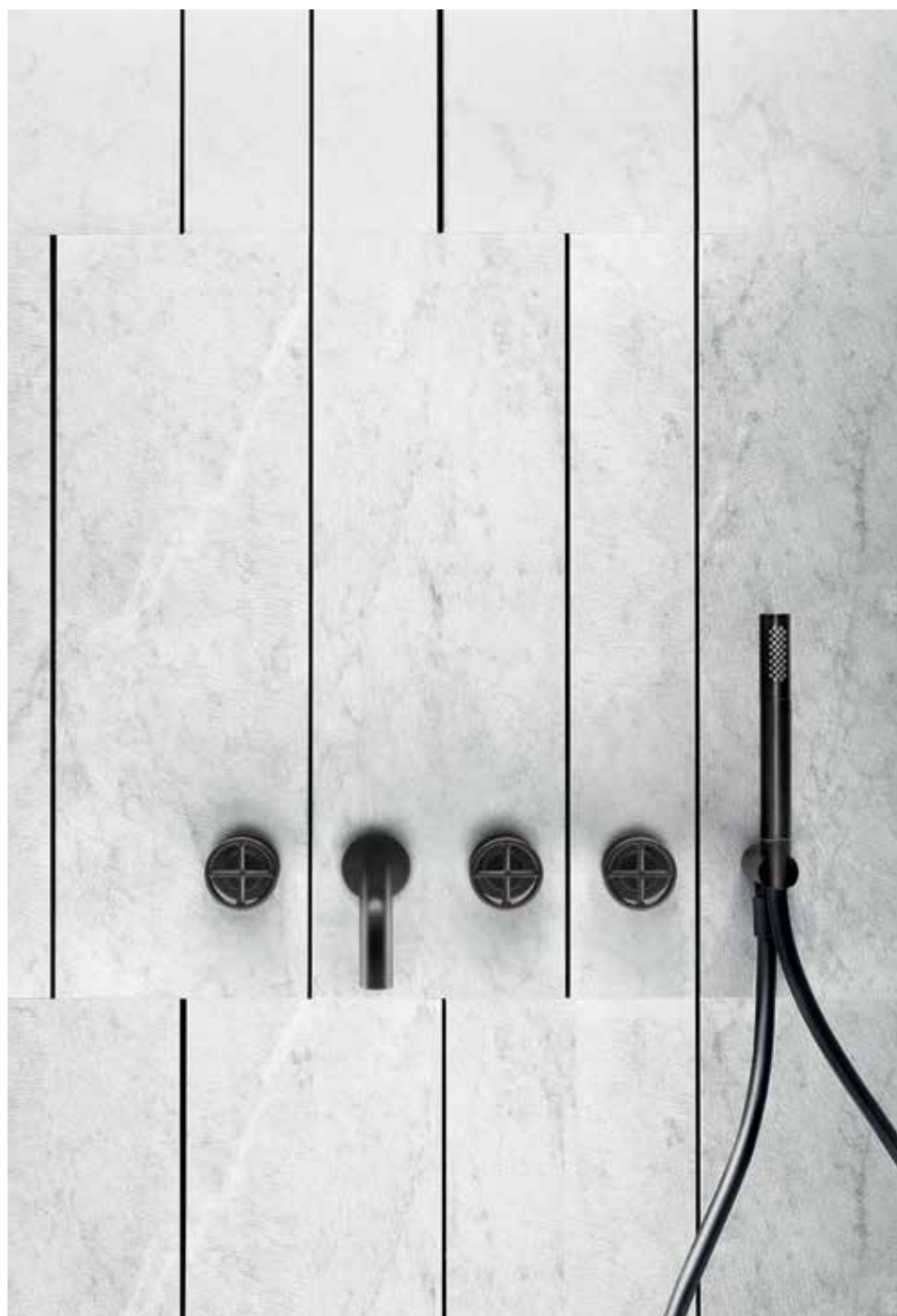

ART. P019B+P019A
Gruppo vasca incasso, interasse bocca 20 cm / Vitoni ceramici
Built-in bathtub mixer, spout projection 20 cm / Ceramic cartridges





pagina accanto / facing page

Texture: Tratti in Bianco Carrara con inserti in alluminio midnight black

Wall: Tratti in Bianco Carrara accented with aluminium inserts in midnight black

ART. P372B+D372A - 8106 - 9237 - 8093

Miscelatore termostatico doccia incasso 3/4", deviatore a rotazione con chiusura a 2 uscite / Cartuccia termostatica - Soffione a pioggia, Ø 20 cm - Braccio doccia, lunghezza 45 cm - Completo doccia

3/4" built-in thermostatic shower mixer, 2-way shut-off diverter with turning knob / Thermostatic cartridge - Rain showerhead, Ø 20 cm - Shower arm, 45 cm long - Shower set

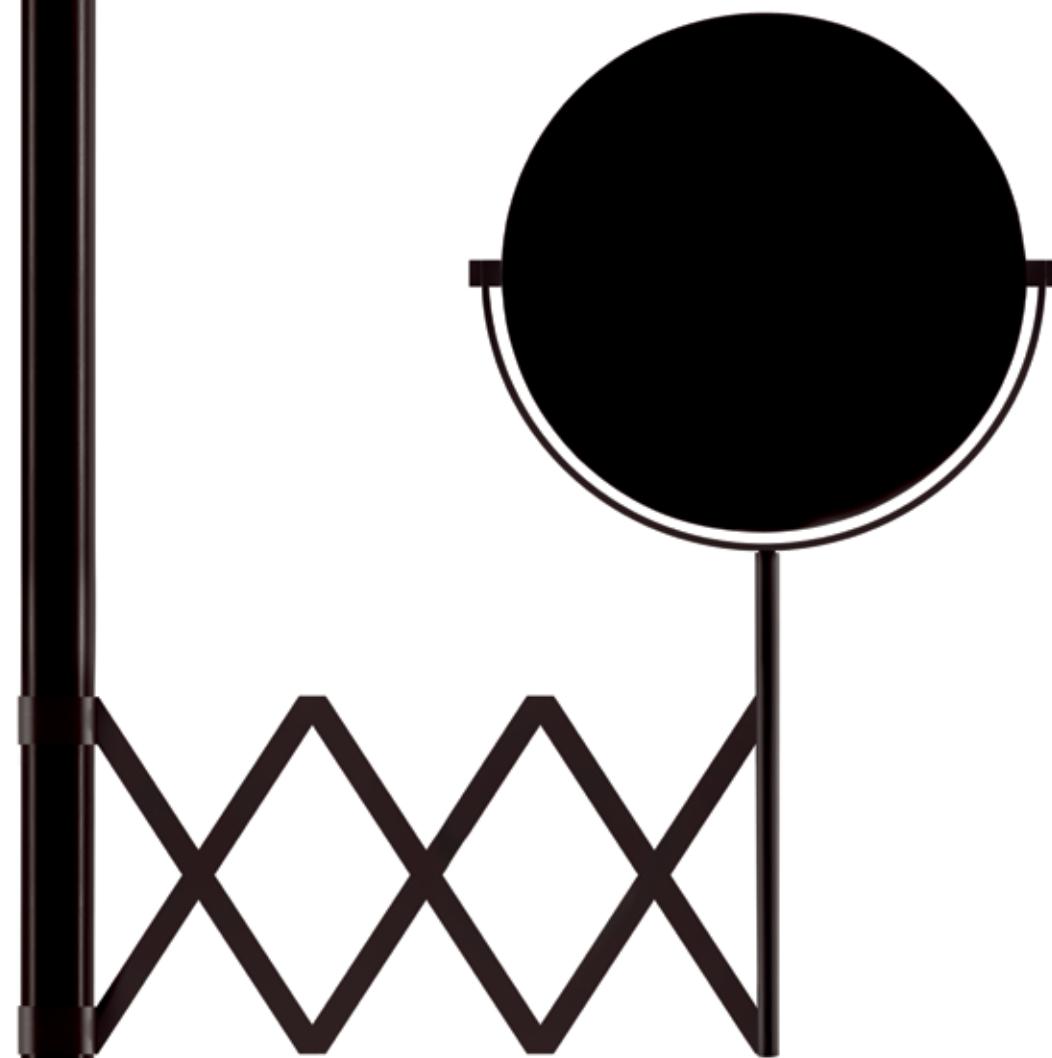

ART. P404C

Specchio, ingranditore, Ø 20 cm, con pantografo fisso

Mirror, magnifying, Ø 20 cm, with fixed pantograph



Parete: Tratti in Bianco Carrara con inserti in alluminio midnight black
 Wall: Tratti in Bianco Carrara accented with aluminium inserts in midnight black

ART. P107W
 Miscelatore lavabo 2 fori, interasse bocca 18,2 cm / Cartuccia progressiva
 2-hole washbasin mixer, spout projection 18,2 cm / Progressive cartridge

pagina accanto / facing page

ART. P007W
 Gruppo lavabo 3 fori, interasse bocca 18,2 cm / Vitoni ceramici
 3-hole washbasin mixer, spout projection 18,2 cm / Ceramic cartridges





pagina accanto / facing page

Parete frontale: Pietra d'Avola Lithoverde® / Pareti laterali e pavimento: Pietra d'Avola levigata
Piatto doccia: Filo Flush 5 | 100 Pietra d'Avola sabbata
Rear wall: Pietra d'Avola Lithoverde® / Side walls and floor: Honed Pietra d'Avola
Shower Tray: Filo Flush 5 | 100 in sandblasted Pietra d'Avola

ART. P685B+M585A - 8106 - 9237 - 8093

Miscelatore vasca/doccia incasso, deviatore a rotazione con chiusura a 2 uscite / Cartuccia tradizionale - Soffione a pioggia, Ø 20 cm - Braccio doccia, lunghezza 45 cm - Completo doccia
Built-in bathtub/shower mixer, 2-way diverter with turning knob / Traditional cartridge - Rain showerhead, Ø 20 cm - Shower arm, 45 cm long - Shower set



Lavabo: Ninfa in Pietra d'Avola / Parete: Pietra d'Avola Lithoverde® / Specchio: Archimede Circle
Basin: Ninfa in Pietra d'Avola / Wall: Pietra d'Avola Lithoverde® / Mirror: Archimede Circle

ART. P113B+M011A
Miscelatore lavabo da parete, interasse bocca 20 cm / Cartuccia tradizionale
Wall-mount washbasin mixer, spout projection 20 cm / Traditional cartridge

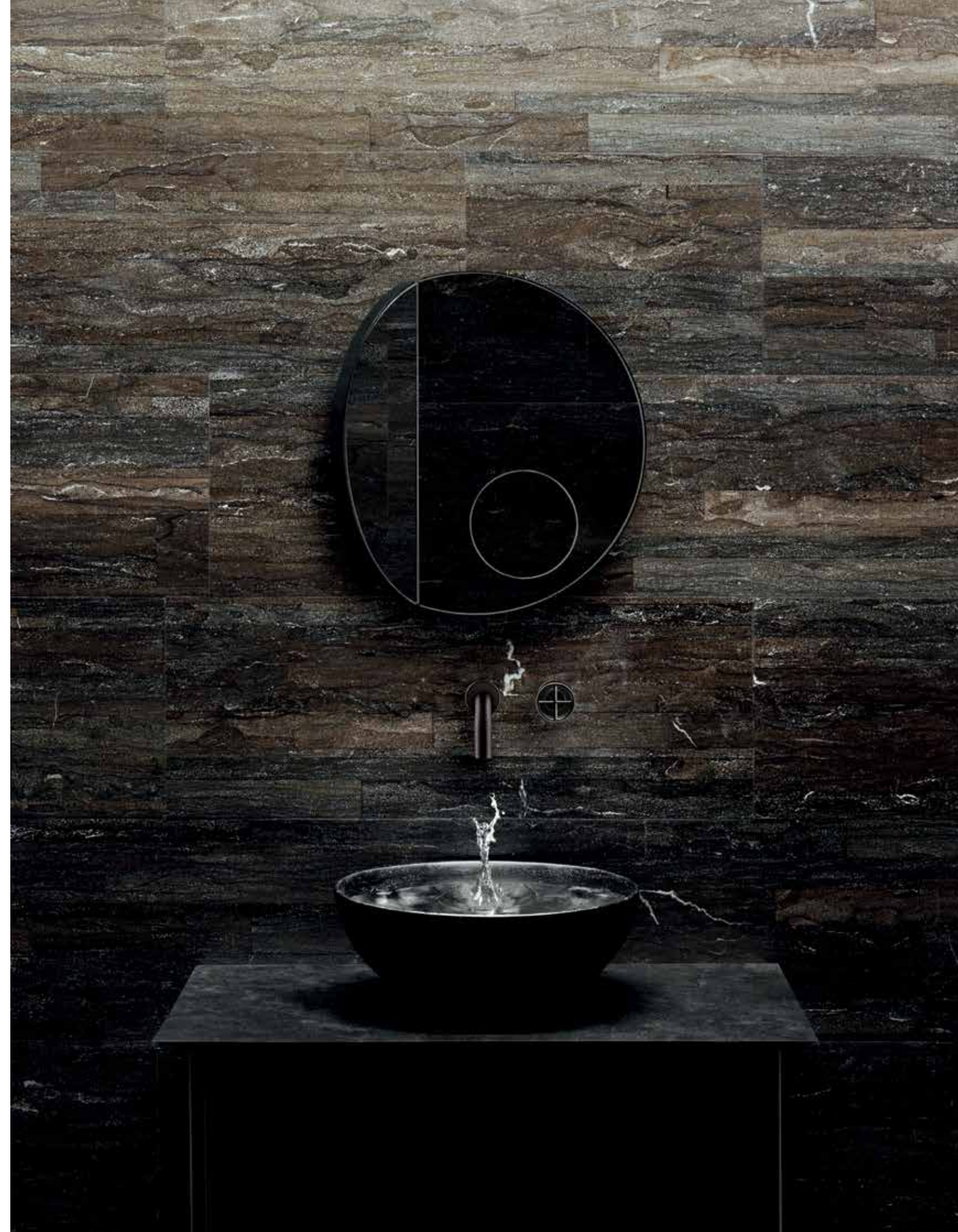

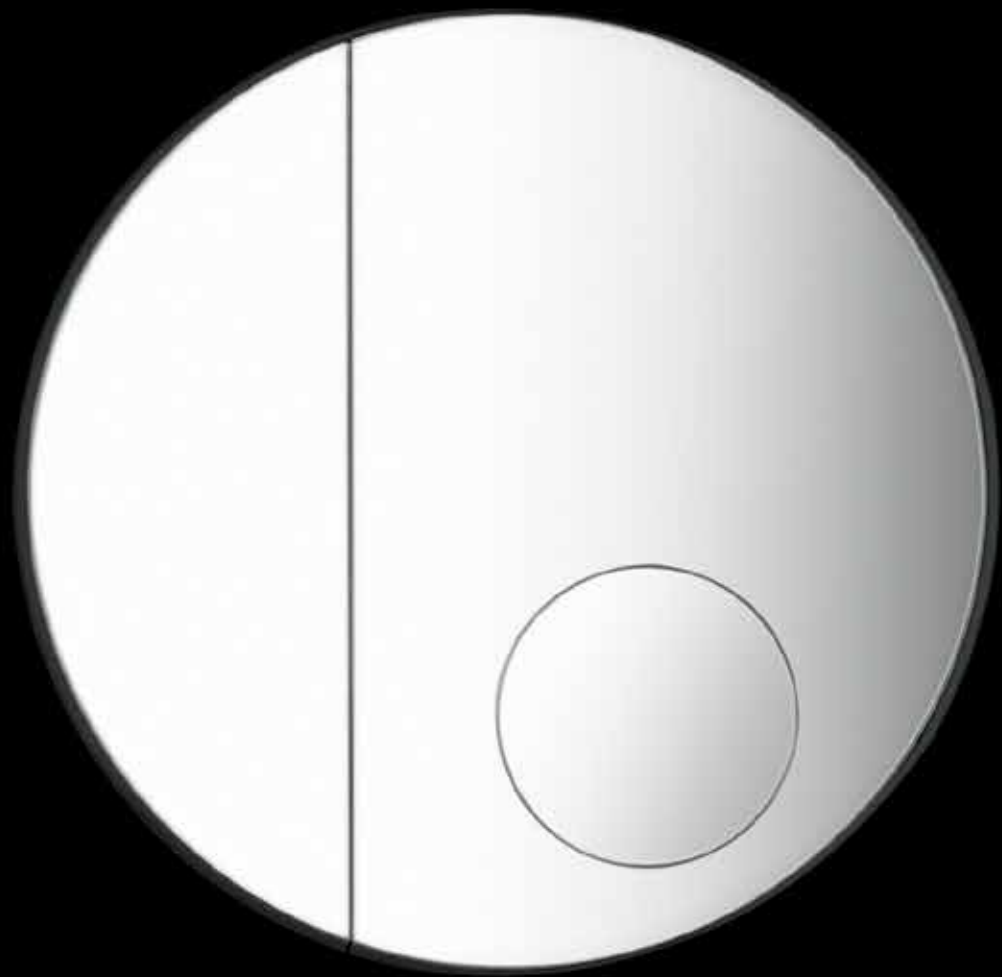

ART. 8106 - 8027
Soffione a pioggia, Ø 20 cm - Braccio doccia, lunghezza 30 cm
Rain showerhead, Ø 20 cm - Shower arm, 30 cm long

pagina accanto / facing page
Specchio: Archimede Circle
Mirror: Archimede Circle



Lavabo: Ninfa in Bianco Carrara / Parete: Bianco Carrara levigato
Pavimento: Bianco Carrara e Pietra d'Avola levigati 7 x 60 cm
Basin: Ninfa in Bianco Carrara / Mini-wall: Honed Bianco Carrara
Floor: Honed Bianco Carrara and Pietra d'Avola 7 x 60 cm

ART. P404B+P404A
Miscelatore lavabo da soffitto, lunghezza bocca 135 cm / Cartuccia progressiva
Ceiling washbasin mixer, spout length: 135 cm / Progressive cartridge
ART. P404C
Specchio, ingranditore, Ø 20 cm, con pantografo fisso
Mirror, magnifying, Ø 20 cm, with fixed pantograph



ART. P404B+P404A
Miscelatore lavabo da soffitto, lunghezza bocca 135 cm / Cartuccia progressiva
Ceiling washbasin mixer, spout length: 135 cm / Progressive cartridge

pagina accanto / facing page
Lavabo: Ninfa in Bianco Carrara
Basin: Ninfa in Bianco Carrara



Lavabo: Alfeo con cassettiere Ciane 60 cm in Crema d'Orcia
Parete frontale: Bamboo in Crema d'Orcia / Pareti laterali e pavimento: Crema d'Orcia levigata
Specchio: Archimede Rectangle
Basin: Alfeo with Ciane 60 cm drawers, all in Crema d'Orcia
Rear wall: Bamboo in Crema d'Orcia / Side walls and floor: Honed Crema d'Orcia
Mirror: Archimede Rectangle



ART. P013B+R010A
Gruppo lavabo da parete, interasse bocca 20 cm / Vitoni ceramici
Wall-mount washbasin mixer, spout projection 20 cm / Ceramic cartridges



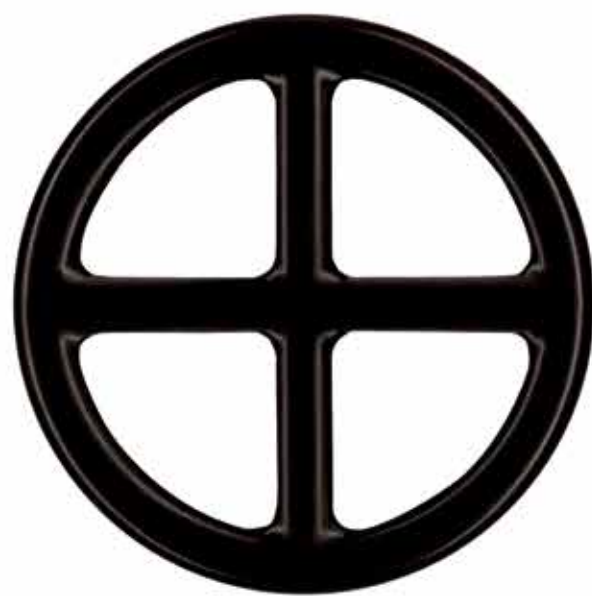

pagina accanto / facing page

Lavabo: Alfeo con cassettiere Ciane 60 cm in Crema d'Orcia
Parete frontale: Bamboo in Crema d'Orcia / Pareti laterali: Crema d'Orcia levigata
Specchio: Archimede Rectangle
Basin: Alfeo with Ciane 60 cm drawers, all in Crema d'Orcia
Rear wall: Bamboo in Crema d'Orcia / Side walls: Honed Crema d'Orcia
Mirror: Archimede Rectangle

ART. PO13B+R010A

Gruppo lavabo da parete, interasse bocca 20 cm / Vitoni ceramici
Wall-mount washbasin mixer, spout projection 20 cm / Ceramic cartridges





ART. 8441
Bocca lavabo da piano, interasse bocca 18,2 cm
Deck-mount washbasin spout, spout projection 18,2 cm

pagina accanto / facing page
Specchio: Archimede Rectangle
Mirror: Archimede Rectangle



Lavabo: Ninfa in Gris du Marais / Parete frontale: Gris du Marais Lithoverde®
Pavimento: Gris du Marais levigato / Tavolo: Dritto 40 x 40 cm in Pietra d'Avola
Basin: Ninfa in Gris du Marais / Rear wall: Gris du Marais Lithoverde®
Floor: Honed Gris du Marais / Table: Dritto 40 x 40 cm in Pietra d'Avola

ART. P110B+M011A

Miscelatore lavabo da parete, interasse bocca 15 cm / Cartuccia tradizionale
Wall-mount washbasin mixer, spout projection 15 cm / Traditional cartridge







nella pagina precedente / previous spread

Lavabo: Alfeo con cassettiere Ciane 60 cm in Bianco Carrara
Parete frontale: Bianco Carrara levigato / Specchio: Archimede Rectangle
Vassoi componibili, portasapone e portaspazzolini in Bianco Carrara
Basin: Alfeo with Ciane 60 cm drawers, all in Bianco Carrara
Rear wall: Honed Bianco Carrara / Mirror: Archimede Rectangle
Modular trays, soap dish, tumbler and toothbrush holder in Bianco Carrara

ART. P113B+M011A

Miscelatore lavabo da parete, interasse bocca 20 cm / Cartuccia tradizionale
Wall-mount washbasin mixer, spout projection 20 cm / Traditional cartridge



Portasapone e porta spazzolini in marmo Bianco Carrara
Soap dish, tumbler and toothbrush holder in Bianco Carrara

pagina accanto / facing page

Portasciugamani con base in marmo Bianco Carrara e anello in acciaio brunito
Towel ring with button in Bianco Carrara and ring in burnished steel

Specchio da tavolo con base in Bianco Carrara
Table mirror in Bianco Carrara

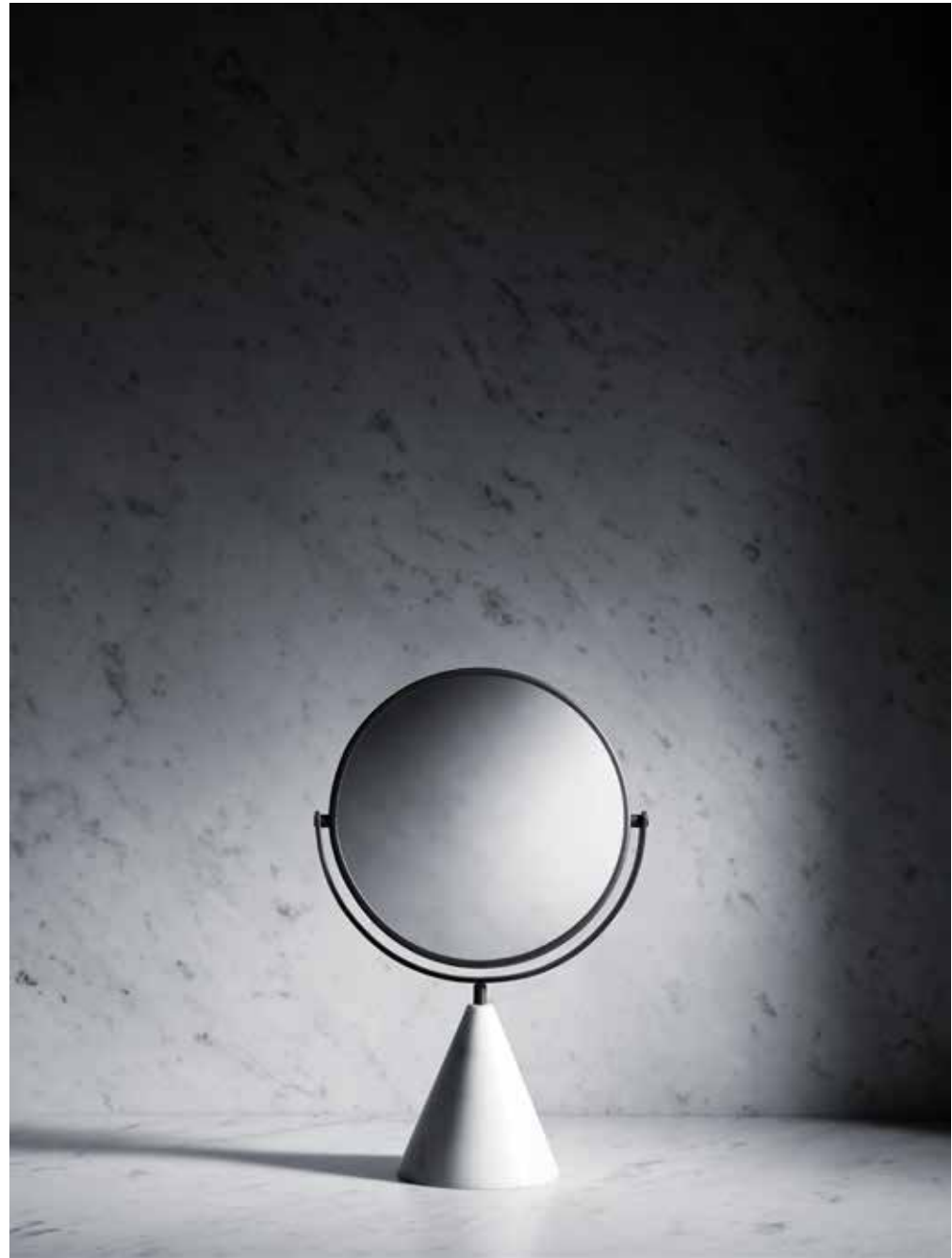

pagina accanto / facing page
Appendiabiti | Wall hooks
Bianco Carrara Verde Alpi

Tutti gli accessori della serie Fontane Bianche sono disponibili
in Bianco Carrara e Pietra d'Avola.
Gli appendiabiti sono disponibili in Bianco Carrara, Verde Alpi, Gris du Marais e Botticino
All accessories in the Fontane Bianche collection are available
in Bianco Carrara and Pietra d'Avola.
Wall hooks are available in Bianco Carrara, Verde Alpi, Gris du Marais and Botticino



ALFEO

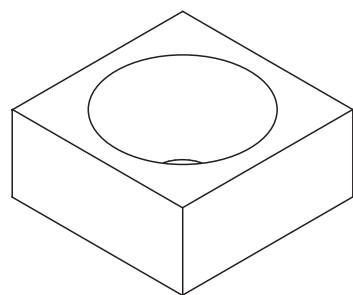

- I** Lavabo in pietra naturale utilizzabile singolarmente o in combinazione con la linea di cassettiere Ciane
Dimensioni: 45 x 45 cm
Altezza: 20 cm
Disponibili in: Bianco Carrara, Gris du Marais, Pietra d'Avola, Crema d'Orcia
- EN** Basin in natural stone which can be used on its own or combined with the Ciane series of drawers
Dimensions: 45 x 45 cm
Height: 20 cm
Available in: Bianco Carrara, Gris du Marais, Pietra d'Avola, Crema d'Orcia
- FR** Lavabo en pierre naturelle qui s'utilise seul ou combiné à la ligne de meubles de rangement Ciane
Dimensions: 45 x 45 cm
Hauteur: 20 cm
Produits proposés en: Bianco Carrara, Gris du Marais, Pietra d'Avola, Crema d'Orcia
- DE** Waschbecken aus Naturstein welches für sich alleine oder in Kombination mit den Schubkästen aus der Ciane Serie genutzt werden kann
Maße: 45 x 45 cm
Höhe: 20 cm
Erhältlich in: Bianco Carrara, Gris du Marais, Pietra d'Avola, Crema d'Orcia
- ES** Lavabo en piedra natural, puede ser utilizado solo o con la serie de cajones Ciane
Dimensiones: 45 x 45 cm
Altura: 20 cm
Disponibile en: Bianco Carrara, Gris du Marais, Pietra d'Avola, Crema d'Orcia
- RU** Раковина из натурального камня, идеально смотрится как одна, так и в комбинации с серией выдвижных ящиков Ciane
Размеры: 45 x 45 см
Высота: 20 см
Имеются в наличии из: Bianco Carrara, Gris du Marais, Pietra d'Avola, Crema d'Orcia

NINFA

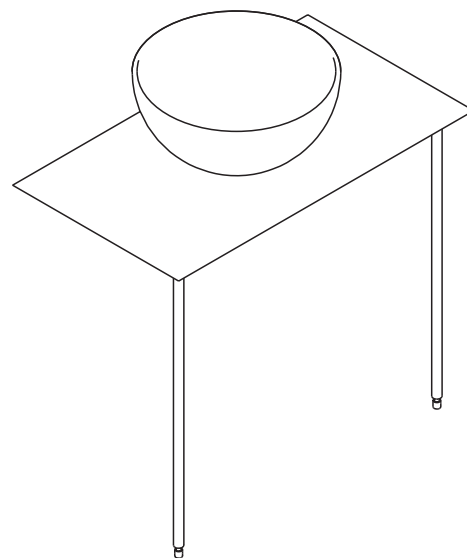

- I** Lavabo e piano di appoggio in pietra, completi di struttura di supporto a pavimento in acciaio color canna di fucile
Dimensioni: 80 x 45 cm
Altezza totale: 90 cm
Disponibili in: Bianco Carrara, Gris du Marais, Pietra d'Avola, Crema d'Orcia
- EN** Basin and top in natural stone with two supporting legs in gunmetal-coloured steel
Dimensions: 80 x 45 cm
Total Height: 90 cm
Available in: Bianco Carrara, Gris du Marais, Pietra d'Avola, Crema d'Orcia
- FR** Lavabo en pierre brute et plan d'appui également en pierre avec structure de support au sol en acier gris « canon de fusil »
Dimensions: 80 x 45 cm
Hauteur totale: 90 cm
Produits proposés en: Bianco Carrara, Gris du Marais, Pietra d'Avola, Crema d'Orcia
- DE** Waschbecken und -Platte aus Naturstein welches auf 2 metallischen Blaugrau rostfreien Stahlbeinen
Maße: 80 x 45 cm
Gesamthöhe: 90 cm
Erhältlich in: Bianco Carrara, Gris du Marais, Pietra d'Avola, Crema d'Orcia
- ES** Lavabo y top en piedra natural con dos soportes de acero color plomo
Dimensiones: 45 x 45 cm
Altura total: 90 cm
Disponibile en: Bianco Carrara, Gris du Marais, Pietra d'Avola, Crema d'Orcia
- RU** Раковина и столешница из натурального камня с опорными металлическими ножками цвета пушечной бронзы
Размеры: 80 x 45 см
Общая высота: 90 см
Имеются в наличии из: Bianco Carrara, Gris du Marais, Pietra d'Avola, Crema d'Orcia

CIANE

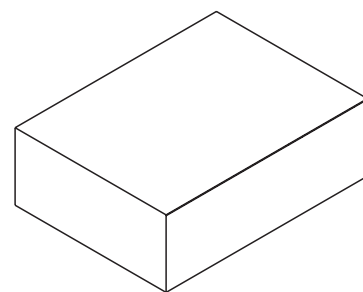

- I** Cassettiere modulari rivestite in pietra con inserti di acciaio color canna di fucile
Dimensioni: 60 x 45 cm e 90 x 45 cm
Altezza: 20 cm
Disponibili in: Bianco Carrara, Gris du Marais, Pietra d'Avola, Crema d'Orcia
- EN** Drawers in natural stone with inserts in gunmetal-coloured steel
Dimensions: 60 x 45 cm and 90 x 45 cm
Height: 20 cm
Available in: Bianco Carrara, Gris du Marais, Pietra d'Avola, Crema d'Orcia
- FR** Meubles de rangement modulables revêtus de pierre avec inserts en acier gris « canon de fusil »
Dimensions: 60 x 45 cm et 90 x 45 cm
Hauteur: 20 cm
Produits proposés en: Bianco Carrara, Gris du Marais, Pietra d'Avola, Crema d'Orcia
- DE** Ciane Aufbewahrungsbausteine Schubkästen aus Naturstein und metallischen blaugrauen rostfreien Stahlunterlagen
Maße: 60 x 45 cm und 90 x 45 cm
Höhe: 20 cm
Erhältlich in: Bianco Carrara, Gris du Marais, Pietra d'Avola, Crema d'Orcia
- ES** Ciane Modulos de almacenamiento Cajones en piedra natural con insertos de acero color plomo
Dimensiones: 60 x 45 cm y 90 x 45 cm
Altura: 20 cm
Disponibile en: Bianco Carrara, Gris du Marais, Pietra d'Avola, Crema d'Orcia
- RU** Ciane Storage Modules Выдвижные ящики из натурального камня с металлическими вставками цвета пушечной бронзы
Размеры: 60 x 40 см+90 x 45 см
Высота: 20 см
Имеются в наличии из: Bianco Carrara, Gris du Marais, Pietra d'Avola, Crema d'Orcia

CIANE

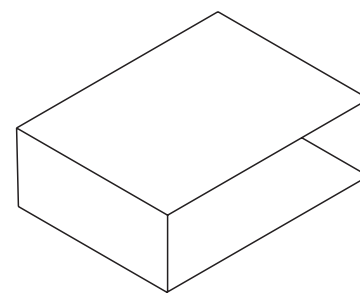

- I** Vano a giorno rivestito in pietra naturale rifinito internamente in acciaio color canna di fucile
Dimensioni: 60 x 45 cm
Altezza: 20 cm
Disponibile in: Bianco Carrara, Gris du Marais, Pietra d'Avola, Crema d'Orcia
- EN** Floating shelf in natural stone with interior finished in gunmetal-coloured steel
Dimensions: 60 x 45 cm
Height: 20 cm
Available in: Bianco Carrara, Gris du Marais, Pietra d'Avola, Crema d'Orcia
- FR** Rangement ouvert revêtu de pierre naturelle avec finition intérieure en acier gris « canon de fusil »
Dimensions: 60 x 45 cm
Hauteur: 20 cm
Produits proposés en: Bianco Carrara, Gris du Marais, Pietra d'Avola, Crema d'Orcia
- DE** Freischwebende Regale aus Naturstein mit Innenverkleidung aus metallischen blaugrauem rostfreiem Stahl
Maße: 60 x 45 cm
Höhe: 20 cm
Erhältlich in: Bianco Carrara, Gris du Marais, Pietra d'Avola, Crema d'Orcia
- ES** Repisa abierta de piedra natural con interiores en acero, terminados en color plomo
Dimensiones: 60 x 45 cm
Altura: 20 cm
Disponibile en: Bianco Carrara, Gris du Marais, Pietra d'Avola, Crema d'Orcia
- RU** Подвесная полка из натурального камня с внутренними металлическими вставками цвета пушечной бронзы
Размеры: 60 x 45 см
Высота: 20 см
Имеются в наличии из: Bianco Carrara, Gris du Marais, Pietra d'Avola, Crema d'Orcia

ARCHIMEDE

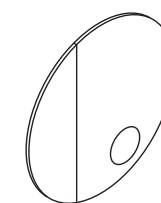

- I** Specchio rotondo con cornice in acciaio color canna di fucile
Ø 60 cm
- EN** Round mirror with frame in gunmetal-coloured steel
Ø 60 cm
- FR** Miroir rond avec cadre en acier gris « canon de fusil »
Ø 60 cm
- DE** Runden Spiegel aus metallischem blaugrauem rostfreiem Stahl
Ø 60 cm
- ES** Espejo redondo en acero color plomo
Ø 60 cm
- RU** Металлическое зеркало цвета пушечной бронзы
Ø 60 см

ARCHIMEDE

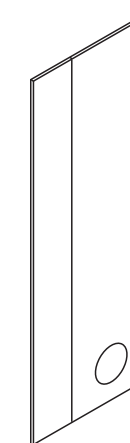

- I** Specchio rettangolare con cornice in acciaio color canna di fucile
Dimensioni: 45 x 120 cm
- EN** Rectangular mirror with frame in gunmetal-coloured steel
Dimensions: 45 x 120 cm
- FR** Miroir rectangulaire avec cadre en acier gris « canon de fusil »
Dimensions: 45 x 120 cm
- DE** Rechteckigen Spiegel aus metallischem blaugrauem rostfreiem Stahl
Maße: 45 x 120 cm
- ES** Espejo rectangularen acero color plomo
Dimensiones: 45 x 120 cm
- RU** Металлическое зеркало цвета пушечной бронзы
Размеры: 45 x 120 см

BIANCO CARRARA



CREMA D'ORCIA

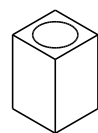

- I** Portaspazzolini in pietra naturale con un unico alloggiamento centrale
Dimensioni: 8 x 8 x h12 cm
- EN** Toothbrush tumbler in natural stone
Dimensions: 8 x 8 x h12 cm
- FR** Porte brosse à dents en pierre naturelle avec un trou unique central
Dimensions: 8 x 8 x h12 cm
- DE** Zahnbürsten-Becher in Naturstein
Maße: 8 x 8 x h12 cm
- ES** Vaso para cepillos de dientes en piedra natural
Dimensiones: 8 x 8 x h12 cm
- RU** Стакан для зубных щеток из натурального камня
Размеры: 8 x 8 см Высота: 12 см

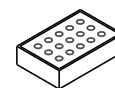

- I** Portasapone in pietra naturale
Dimensioni: 8 x 12 x h3 cm
- EN** Soap dish in natural stone
Dimensions: 8 x 12 x h3 cm
- FR** Porte Savon en pierre naturelle
Dimensions: 8 x 12 x h3 cm
- DE** Seifenschale aus Naturstein
Maße: 8 x 12 x h3 cm
- ES** Jabonera en piedra natural
Dimensiones: 8 x 12 x h3 cm
- RU** Мыльница из натурального камня
Размеры: 8 x 12 см / Высота: 3 см



- I** Portasciugamani con corpo in pietra naturale e anello di appoggio in acciaio brunito
Diametro: 24 cm / Profondità 8 cm
- EN** Towel ring with button in natural stone and ring in burnished steel
Diameter: 24 cm / Height 8 cm
- FR** Porte-serviettes en pierre naturelle avec anneau en acier bruni
Diamètre: 24 cm / Hauteur: 8 cm
- DE** Handtuchring mit Knopf aus Naturstein und Ring aus poliertem Edelstahl
Durchmesser: 24 cm / Höhe: 8 cm
- ES** Toallero con cuerpo central en piedra natural y anillo en acero bruñido
Diámetro: 24 cm / Altura 8 cm
- RU** Кольцо для полотенец с кнопкой из природного камня и кольцом из полированной стали
Диаметр: 24 см / Высота: 8 см

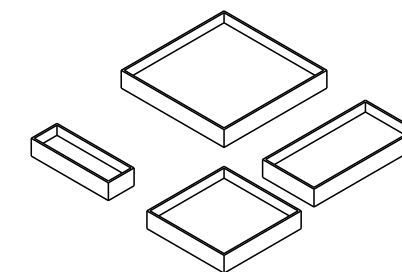

- I** Set di vassoi componibili con base di appoggio in pietra naturale
Dimensioni: 20 x 20 cm / 15 x 5 cm / 10 x 20 cm / 15 x 15 cm / h3 cm
- EN** Set of modular trays with base in natural stone
Dimensions: 20 x 20 cm / 15 x 5 cm / 10 x 20 cm / 15 x 15 cm / all h 3cm
Height: 3 cm
- FR** Série de plateaux modulaires avec base en pierre naturelle
Dimensions: 20 x 20 cm / 15 x 5 cm / 10 x 20 cm / 15 x 15 cm / h3 cm
Hauteur: 3 cm
- DE** Set aus Modularschalen auf Natursteinbasis
Maße: 20 x 20 cm / 15 x 5 cm / 10 x 20 cm / 15 x 15 cm / h 3 cm
- ES** Equipo de bandejas modulares con base en piedra natural
Dimensiones: 20 x 20 cm / 15 x 5 cm / 10 x 20 cm / 15 x 15 cm / h 3 cm
- RU** Мыльница из натурального камня
Размеры: 20 x 20 см / 15 x 5 см / 10 x 20 см / 15 x 15 см / Высота: 3 см

GRIS DU MARAIS



PIETRA D'AVOLA

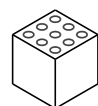

- I** Portaspazzolini in pietra naturale con 9 alloggi
Dimensioni: 8 x 8 x h8 cm
- EN** 9-hole toothbrush holder in natural stone
Dimensions: 8 x 8 x h8 cm
- FR** Porte brosse à dents en pierre naturelle avec 9 trous
Dimensions: 8 x 8 x h8cm
- DE** 9-Loch Zahnbürstenhalter aus Naturstein
Maße: 8 x 8 x h8 cm
- ES** Vaso para cepillos de dientes con 9 huecos en piedra natural
Dimensiones: 8 x 8 x h8 cm
- RU** Держатель с 9 отверстиями из натурального камня
Размеры: 8 x 8 см / Высота: 8 см



- I** Specchio da tavolo con base di appoggio in pietra naturale
Diametro specchio: 10 cm / Altezza 31 cm
- EN** Table mirror with base in natural stone
Diameter mirror: 10 cm / Height 31 cm
- FR** Miroir de table avec base en pierre naturelle
Diamètre du miroir: 10 cm / Hauteur: 31 cm
- DE** Tischspiegel mit Sockel aus Naturstein
Durchmesser Spiegel: 10 cm / Höhe: 31 cm
- ES** Espejo de mesa con base en piedra natural
Diámetro del espejo: 10 cm / Altura 31 cm
- RU** Настольное зеркало с основой из натурального камня
Диаметр зеркала: 10 см / Высота: 31 см

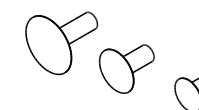

- I** Set di appendiabiti in pietra naturale
Diametro: 7 x h4 cm / 9 x h8 cm / 12 x h11 cm
- EN** Wall hooks in natural stone
Diameter: 7 x h4 cm / 9 x h8 cm / 12 x h11 cm
- FR** Série de cintres en pierre naturelle
Diamètre: 7 x h4 cm / 9 x h 8cm / 12 x h11 cm
- DE** Wandhaken aus Naturstein
Durchmesser: 7 x h4 cm / 9 x h8 cm / 12 x h11 cm
- ES** Perchero en piedra natural
Diámetro: 7 x h4 cm / 9 x h8 cm / 12 x h11 cm
- RU** Стеновые крючки из натурального камня
Диаметр: 7 см / 9 см / 12 см
Высота: 4 см / 8 см / 11 см

P404B+P404A

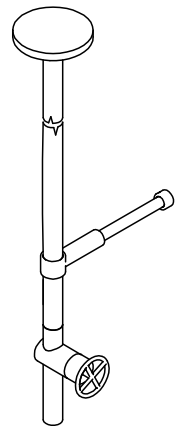

- I** Miscelatore lavabo da soffitto, lunghezza bocca 135 cm / Cartuccia progressiva
- EN** Ceiling washbasin mixer, spout length: 135 cm / Progressive cartridge
- FR** Mitigeur lavabo à plafond, bec 135 cm / Cartouche progressive
- DE** Deckenmontierter Waschtischmischer, Auslauflänge: 135 cm / Progressivkartusche
- ES** Monomando lavado de techo, longitud caño 135 cm / Cartucho progresivo
- RU** Потолочный смеситель для раковины, длина излива: 135 см / Прогрессивный картридж

P494

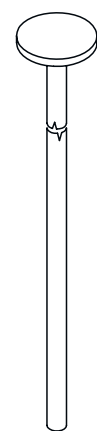

- I** Bocca lavabo da soffitto, lunghezza bocca 140 cm
- EN** Ceiling-mount washbasin spout, spout length: 140 cm
- FR** Bec lavabo à plafond, bec 140 cm
- DE** Deckenmontierter Waschtischauslauf, Auslauflänge: 140 cm
- ES** Caño lavabo a techo, longitud caño 140 cm
- RU** Излив потолочный, длина излива: 140 см

P404C

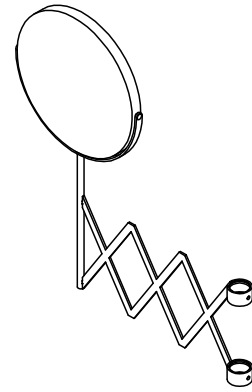

- I** Specchio, ingranditore, Ø 20 cm, con pantografo fisso
- EN** Mirror, magnifying, Ø 20 cm, with fixed pantograph
- FR** Miroir, grossissant, Ø 20 cm, avec pantographe fixe
- DE** Vergrößerungsspiegel, Ø 20 cm, mit feststehendem Pantograph
- ES** Espejo, de aumento, Ø 20 cm, con pantógrafo fijo
- RU** Зеркало, увеличительное, Ø 20 см, с фиксированным пантографом

P107W

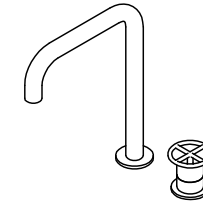

- I** Miscelatore lavabo 2 fori, interasse bocca 18,2 cm / Cartuccia progressiva
- EN** 2-hole washbasin mixer, spout projection 18,2 cm / Progressive cartridge
- FR** Mitigeur lavabo 2 trous, entraxe bec 18,2 cm / Cartouche progressive
- DE** 2-Loch-Waschtischmischer, Achsabstand Auslauf 18,2 cm / Progressivkartusche
- ES** Monomando lavabo 2 elementos, distancia a chorro 18,2 cm / Cartucho progresivo
- RU** Смеситель для раковины на 2 отверстия, вылет 18,2 см / Прогрессивный картридж

P007W / P007



- I** Gruppo lavabo 3 fori, interasse bocca 18,2cm/ Vitoni ceramici / senza scarico / con scarico
- EN** 3-hole washbasin mixer, spout projection 18,2 cm / Ceramic cartridges / without waste / with waste
- FR** Mélangeur lavabo 3 trous, entraxe bec 18,2 cm / Têtes céramiques / sans vidage / avec vidage
- DE** 3-Loch-Waschtischmischer, Achsabstand Auslauf 18,2 cm / Keramikoberteil / ohne Ablauf / mit Ablauf
- ES** Batería lavabo 3 elementos, distancia a chorro 18,2 cm / Cartuchos de disco cerámico / sin desagüe / con desagüe
- RU** Смеситель для раковины на 3 отверстия, вылет 18,2 см / Керамический картридж / без донного клапана / с донным клапаном

P010B+R010A / P013B+R010A

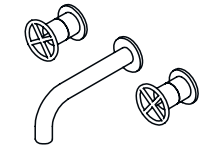

- I** Gruppo lavabo da parete, interasse bocca 15 cm / Interasse bocca 20 cm / Vitoni ceramici
- EN** Wall-mount washbasin mixer, spout projection 15 cm / Spout projection 20 cm / Ceramic cartridges
- FR** Mélangeur lavabo mural, entraxe bec 15 cm/ Entraxe bec 20 cm / Têtes céramiques
- DE** Wandwaschtischmischer, Achsabstand Auslauf 15 cm / Achsabstand Auslauf 20 cm / Keramikoberteil
- ES** Batería lavabo a pared, distancia a chorro 15 cm / Distancia a chorro 20 cm / Cartuchos de disco cerámico
- RU** Смеситель из стены для раковины, излив 15 см / излив 20 см / Керамический картридж

8441

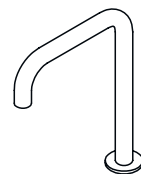

- I** Bocca lavabo da piano, interasse bocca 18,2 cm
- EN** Deck-mount washbasin spout, spout projection 18,2 cm
- FR** Bec lavabo sur plan, entraxe bec 18,2 cm
- DE** Waschtischauslauf, Achsabstand Auslauf 18,2 cm
- ES** Caño lavabo de apoyo, distancia a chorro 18,2 cm
- RU** Излив, установка на столешницу, вылет 18,2 см

8442 / 8443



- I** Bocca lavabo da parete, interasse bocca 15 cm / Interasse bocca 20 cm
- EN** Wall-mount washbasin spout, spout projection 15 cm / Spout projection 20 cm
- FR** Bec pour mitigeur lavabo mural, entraxe bec 15 cm / Entraxe bec 20 cm
- DE** Waschbeckenwandeinlauf, Achsabstand Auslauf cm 15 / Achsabstand Auslauf 20 cm
- ES** Caño lavabo a pared, distancia a chorro cm 15 / Distancia a chorro 20 cm
- RU** Излив настенный, вылет 15 см / вылет 20 см

P495



- I** Comando remoto da piano / Cartuccia progressiva
- EN** Deck-mount remote control / Progressive cartridge
- FR** Commande déportée sur plage / Cartouche progressive
- DE** Waschtischmischer / Progressivkartusche
- ES** Monomando sobre encimera / Cartucho progresivo
- RU** Набротное управление / Прогрессивный картридж

P110B+M011A / P113B+M011A

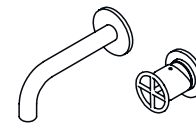

- I** Miscelatore lavabo da parete, interasse bocca 15 cm / Interasse bocca 20 cm/ Cartuccia tradizionale
- EN** Wall-mount washbasin mixer, spout projection 15 cm / Spout projection 20 cm / Traditional cartridge
- FR** Mitigeur lavabo mural, entraxe bec 15 cm / Entraxe bec 20 cm / Cartouche traditionnelle
- DE** Wandwaschtischmischer, Achsabstand Auslauf 15 cm / Achsabstand Auslauf 20 cm / Standardkartusche
- ES** Monomando lavabo a pared, distancia a chorro 15 cm / Distancia a chorro 20 cm / Cartucho tradicional
- RU** Смеситель из стены для раковины, излив 15 см / излив 20 см / Традиционный картридж

P008W / P008



- I** Miscelatore bidet monoforo, interasse bocca 13,4 cm / Cartuccia progressiva / senza scarico / con scarico
- EN** Single-hole bidet mixer, spout projection 13,4 cm / Progressive cartridge / without waste / with waste
- FR** Mitigeur bidet monotrou, entraxe bec 13,4 cm / Cartouche progressive
- DE** 1-Loch-Bidetmischer, Achsabstand Auslauf 13,4 cm / Progressivkartusche/ ohne Ablauf/ mit Ablauf
- ES** Monobloc bidé, distancia a chorro 13,4 cm/ Cartucho progresivo/ sin desagüe / con desagüe
- RU** Смеситель для биде, вылет 13,4 см / Прогрессивный картридж / без донного клапана / с донным клапаном

P063B+M063A



- I** Miscelatore doccia incasso / Cartuccia tradizionale
- EN** Built-in shower mixer / Traditional cartridge
- FR** Mitigeur douche à encastrer / Cartouche traditionnelle
- DE** UP-Brausemischer / Standardkartusche
- ES** Monomando ducha empotrado / Cartucho tradicional
- RU** Встраиваемый смеситель для душа / Термостатический картридж

P685B+M585A / P687B+M587A



- I** Miscelatore doccia incasso, deviatore a rotazione, 2 uscite / 3 uscite / Cartuccia tradizionale
- EN** Built-in shower mixer, with turning knob, 2-way/ 3-way diverter / Traditional cartridge
- FR** Mitigeur douche à encastrer, inverseur à rotation, 2 sorties / 3 sorties / Cartouche traditionnelle
- DE** UP-Brausemischer, Drehumsteller, 2-Wege / 3-Wege / Standardkartusche
- ES** Monomando ducha empotrado, desviador giratorio, 2 salidas / 3 salidas / Cartucho tradicional
- RU** Встраиваемый смеситель для душа, переключатель с поворотной кнопкой, на 2 потока / на 3 потока / Традиционный картридж

P331B+D331A / P372B+D372A / P373B+D373A

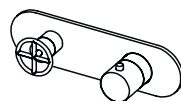

- I** Miscelatore termostatico doccia incasso 3/4", 1 uscita / 2 uscite / 3 uscite / Cartuccia termostatica
- EN** 3/4" built-in thermostatic shower mixer, 1 outlet / 2 outlets / 3 outlets / Thermostatic cartridge
- FR** Mitigeur thermostatique douche à encastrer 3/4", 1 sortie / 1 sorties / 2 sorties / 3 sorties / Cartouche thermostatique
- DE** 3/4" UP-Thermostatbrausemischer, 1 Ausgang / 2 Ausgänge / 3 Ausgänge / Thermostatkartusche
- ES** Monomando termostático ducha empotrado 3/4", 1 salida / 2 salidas / 3 salidas / Cartucho termostático
- RU** Термостатический встраиваемый смеситель для душа, 3/4", 1 выпуск / 2 выпуска / 3 выпуска / термостатический картридж

P300B+D300A



- I** Miscelatore termostatico doccia incasso 3/4" / Cartuccia termostatica
- EN** 3/4" built-in thermostatic shower mixer / Thermostatic cartridge
- FR** Mitigeur thermostatique douche à encastrer 3/4" / Cartouche thermostatique
- DE** 3/4" UP-Thermostatbrausemischer / Thermostatkartusche
- ES** Monomando termostático ducha empotrado 3/4" / Cartucho termostático
- RU** Термостатический встраиваемый смеситель для душа, 3/4" / Термостатический картридж

9236 / 9237



- I** Braccio doccia, lunghezza 25 cm / Lunghezza 45 cm
- EN** Shower arm, 25 cm long / 45 cm long
- FR** Bras de douche, longueur 25 cm / Longueur 45 cm
- DE** Brausearm, Länge 25 cm / Länge 45 cm
- ES** Brazo ducha, longitud 25 cm / Longitud 45 cm
- RU** Кронштейн для душевой лейки, длина 25 см / длина 45 см

8093

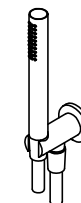

- I** Completo doccia
- EN** Shower set
- FR** Combiné de douche
- DE** Brauseset
- ES** Conjunto de ducha
- RU** Душевой набор

P019B+P019A

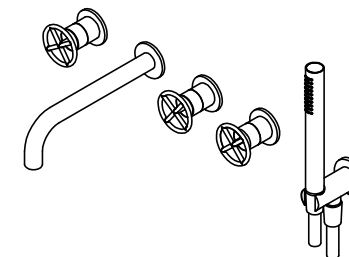

- I** Gruppo vasca incasso, interasse bocca 20 cm / Vitoni ceramici
- EN** Built-in bathtub mixer, spout projection 20 cm / Ceramic cartridges
- FR** Mélangeur bain-douche à encastrer, entraxe bec 20 cm / Têtes céramiques
- DE** UP-Wannenmischer, Achsabstand Auslauf 20 cm / Keramikoberteil
- ES** Grupo baño/ducha empotrado, distancia a chorro 20 cm / Cartuchos de disco cerámico
- RU** Встроенный смеситель для ванны, вылет 20 см / Керамический картридж

P391B+D391A



- I** Rubinetto di arresto 3/4" / Vitone ceramico
- EN** 3/4" stop valve / Ceramic cartridge
- FR** Robinet d'arrêt 3/4" / Tête céramique
- DE** 3/4" Absperrventil / Keramikventil
- ES** Llave de paso 3/4" / Cartucho de disco cerámico
- RU** Запорный вентиль 3/4" / картридж керамический

8106



- I** Soffione a pioggia, Ø 20 cm
- EN** Rain showerhead, Ø 20 cm
- FR** Pomme de douche jet pluie, Ø 20 cm
- DE** Regenkopfbrause, Ø 20 cm
- ES** Rociador lluvia, Ø 20 cm
- RU** Верхний душ, Ø 20 см

8027 / 8028

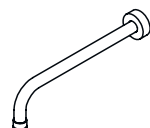

- I** Braccio doccia, lunghezza 30 cm / Lunghezza 45 cm
- EN** Shower arm, 30 cm long / 45 cm long
- FR** Bras de douche, longueur 30 cm / Longueur 45 cm
- DE** Brausearm, Länge 30 cm / Länge 45 cm
- ES** Brazo ducha, longitud 30 cm / Longitud 45 cm
- RU** Кронштейн для душевой лейки, длина 30 см / длина 45 см

P017B+P017A

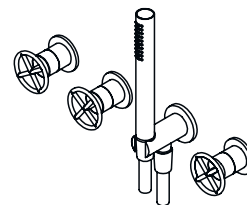

- I** Gruppo vasca / doccia incasso / Vitoni ceramici
- EN** Built-in bathtub / shower mixer / Ceramic cartridges
- FR** Mélangeur bain-douche/douche à encastrer / Têtes céramiques
- DE** UP-Wannen- und Brausemischer / Keramikoberteil
- ES** Grupo baño/ducha empotrado / Cartuchos de disco cerámico
- RU** Душевой набор / Керамический картридж

P065

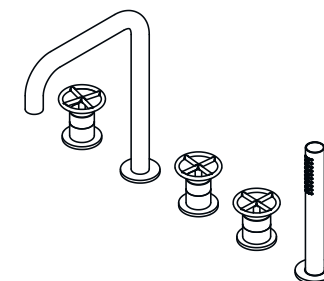

- I** Gruppo vasca, interasse bocca 18,2 cm / Vitoni ceramici
- EN** Deck-mount bathtub mixer, spout projection 18,2 cm / Ceramic cartridges
- FR** Mélangeur bain-douche sur gorge, entraxe bec 18,2 cm / Têtes céramiques
- DE** Wannenrandmischer, Achsabstand Auslauf 18,2 cm / Keramikoberteil
- ES** Grupo bañera repisa, distancia a chorro 18,2 cm / Cartuchos de disco cerámico
- RU** Наборный смеситель для ванны, вылет 18,2 см / Керамический картридж

P080B+R080A

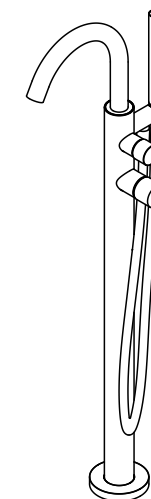

- I** Miscelatore vasca da pavimento, interasse bocca 20 cm / Cartuccia tradizionale
- EN** Floor-mount bathtub mixer, spout projection 20 cm / Traditional cartridge
- FR** Mitigeur bain-douche installation au sol, entraxe bec 20 cm / Cartouche traditionnelle
- DE** Bodenstand-Wannenmischer, Achsabstand Auslauf 20 cm / Standardkartusche
- ES** Monomando baño/ducha a suelo, distancia a chorro 25 cm / Cartucho tradicional
- RU** Напольный смеситель для ванны, вылет излива 25 см / Традиционный картридж

Art Direction **Elisa Ossino Studio**

Photography **Tommaso Sartori** (pagine 4, 8, 9, 16, 17, 19, 22, 23, 26, 27, 33)
Kasia Gatkowska (pagine 7, 10, 11, 12, 14, 15, 29, 34, 35, 36, 37, 38, 39)

Graphic Design **Duška Karanov**

Thanks to **Michele Reginaldi**

SALVATORI
DAL 1946

Alfredo Salvatori srl
via Aurelia 395/E
55047 Querceta LU
Italy
T. +39 0584 769 200
salvatori.it
info@salvatori.it



Fratelli Fantini Spa
via M. Buonarroti 4
28010 Pella NO
Italy
T. +39 0322 918411
fantini@fantini.it
www.fantini.it

Cod. 110000327REV0003

SALVATORI

DAL 1946



 FANTINI
RUBINETTI